

USING DUPIXENT® CORRECTLY

A guide to correctly using the DUPIXENT®
pre-filled syringe

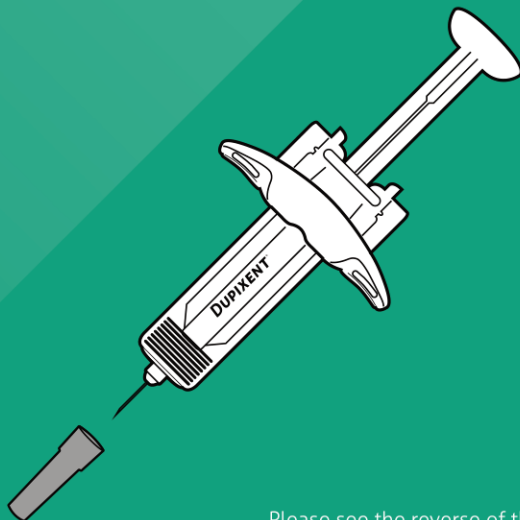

Please see the reverse of this
brochure on how to use the
DUPIXENT® pre-filled pen.

sanofi

REGENERON®

DEAR PATIENT

Your doctor has prescribed you DUPIXENT® solution for injection in the form of a pre-filled syringe with an automatic safety system.

DUPIXENT® is injected under the skin once every 2 weeks – a type of administration known as subcutaneous injection. Each pre-filled syringe contains a dose of 200 mg or 300 mg DUPIXENT®. The dose must be administered in full and must not be divided. The dose to be administered is determined by your doctor.

Your doctor will decide with you whether you should inject DUPIXENT® yourself and when you should do it. Only inject DUPIXENT® yourself if you have been instructed to do so beforehand by your treatment team. For adolescents over 12 years of age, it is recommended that DUPIXENT® be administered by an adult or under adult supervision.

Note:

This brochure is intended to supplement the package leaflet, not replace it. Make sure you read the package leaflet in its entirety before starting the therapy. The package leaflet is included in every pack of DUPIXENT®. You can also find it online at: www.mein.sanofi.de/produkte/Dupixent.

IMPORTANT INFORMATION

- Read all the directions in the instructions for use through carefully before using the pre-filled syringe.
- Ask your doctor, pharmacist or nurse how often you must inject DUPIXENT®.
- Make sure your treatment team show you how to use the pre-filled syringe correctly before you give yourself an injection for the first time.
- Change the puncture site (injection site) each time you inject.
- **Do not use the syringe** if it has been dropped on a hard surface or is damaged.
- **Do not use the pre-filled syringe** if the needle shield is missing or not correctly attached.
- **Do not touch the syringe plunger** until you are ready to give the injection.
- **Do not inject** through clothing.
- **Do not remove** air bubbles in the syringe.
- To prevent unintentional needle-stick injuries, each pre-filled syringe has an automatic safety system that is automatically activated after the injection to cover the needle.
- **Never pull the syringe plunger** back.
- **Do not reuse the pre-filled syringe.**

COMPONENTS OF THE DUPIXENT® PRE-FILLED SYRINGE WITH AUTOMATIC SAFETY SYSTEM

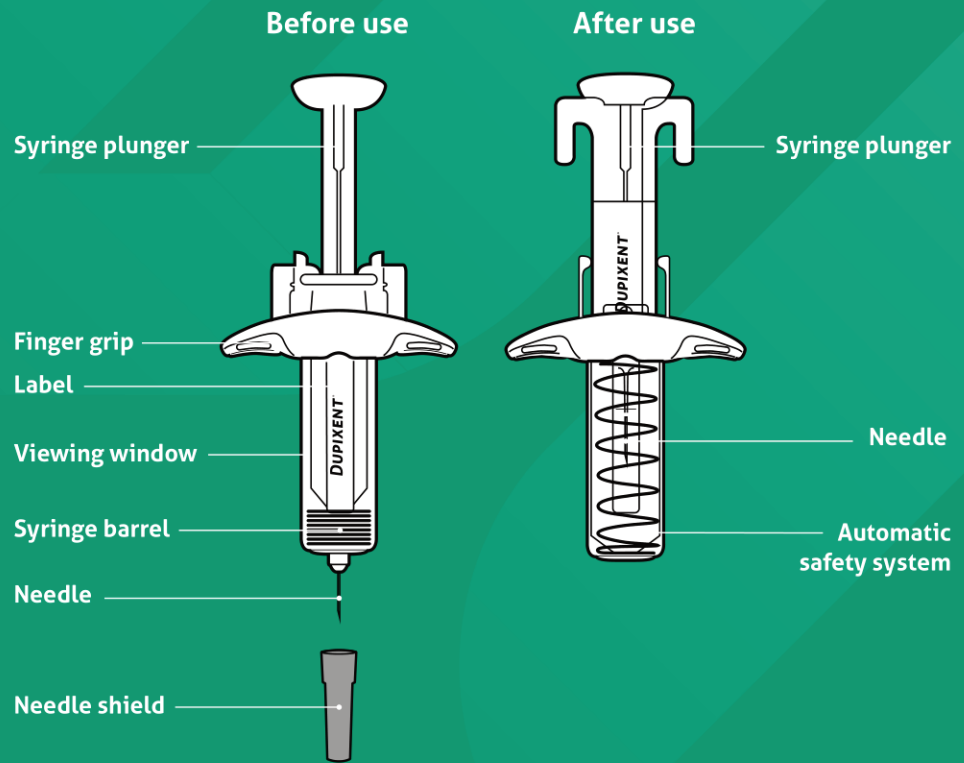

To prevent unintentional needle-stick injuries, each pre-filled syringe has an automatic safety system that is automatically activated after the injection to cover the needle.

01 STEP-BY-STEP INSTRUCTIONS FOR ADMINISTERING A DUPIXENT® INJECTION

STEP 1: REMOVE FROM PACKAGING

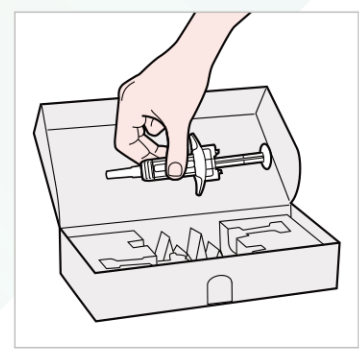

Remove the pre-filled syringe from the outer carton by picking it up around the middle.

- Do not remove the needle shield until you are ready to give the injection.
- Do not use the pre-filled syringe if it has been dropped on a hard surface or has been damaged.

STEP 2: PREPARATION

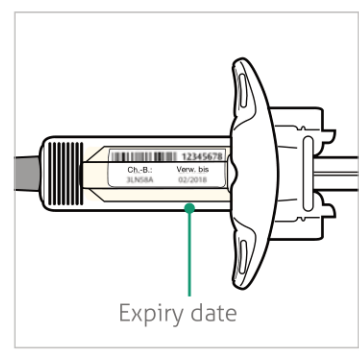

Ensure you have the following at ready:

- DUPIXENT® pre-filled syringe
- 1 alcohol wipe*
- 1 piece of cotton wool or gauze wipe*
- 1 puncture-resistant container* (see step 12)

Look at the label:

- Check the expiry date.
- Check that you have the correct medicine and the correct dose.

- Do not use the pre-filled syringe after the expiry date.
- Do not store DUPIXENT® for more than 14 days at room temperature.

* Not included in the outer carton.

STEP 3: LOOK AT THE MEDICINE

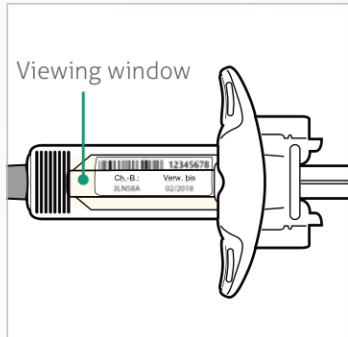

Look at the medicine through the viewing window of the pre-filled syringe: Check that the liquid is clear and colourless to pale yellow.

Note: You might see an air bubble. This is normal.

- Do not use the pre-filled syringe if the liquid is cloudy or discoloured or if it contains precipitates or particles.

STEP 4: WAIT 30 MINUTES (FOR 200 MG DUPIXENT®) OR 45 MINUTES (FOR 300 MG DUPIXENT®)



Leave the syringe on a flat surface for at least 30 minutes or 45 minutes until it reaches room temperature.

- Do not warm the pre-filled syringe in the microwave, using hot water or by placing it in direct sunlight.
- Do not expose the pre-filled syringe to direct sunlight.
- Do not store DUPIXENT® for more than 14 days at room temperature.

STEP 5: SELECTION OF THE INJECTION SITE

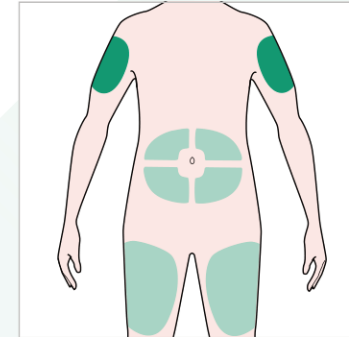

- Self-injection or injection by a caregiver
- Injection only by a caregiver

Select the injection site.

- You can inject into your thigh or abdomen (lower abdomen) but keep 5 cm away from your navel.
- If somebody else gives you the injection, the upper arm can also be injected.
- Change the injection site each time you inject.

- Do not inject into skin that is tender, injured, scarred or bruised.

STEP 6: CLEAN THE INJECTION SITE



- Wash your hands.
- Clean the injection site with an alcohol wipe.
- Allow the skin at the injection site to dry before injecting.

- Do not touch the injection site again or blow on it before the injection.

STEP 7: REMOVE THE NEEDLE SHIELD

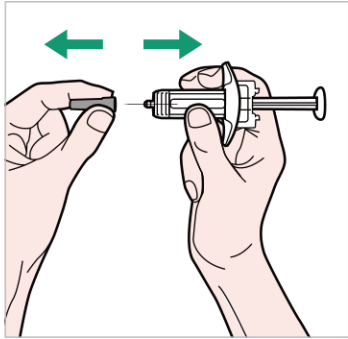

Hold the pre-filled syringe in the middle of the syringe barrel so that the needle points away from you. Remove the needle shield.

! Do not put the needle shield back on the pre-filled syringe.

! Do not touch the needle.

Inject DUPIXENT® immediately after you have removed the needle shield.

STEP 8: PINCH THE SKIN

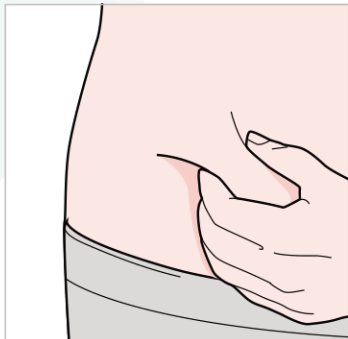

Pinch a fold of skin at the injection site as shown in the diagram.

STEP 9: INSERT THE NEEDLE

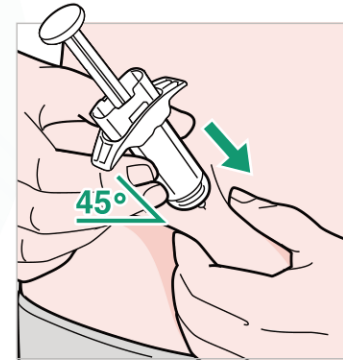

Insert the needle fully into the fold of skin at an angle of about 45°.

STEP 10: PRESS THE PLUNGER ROD DOWN

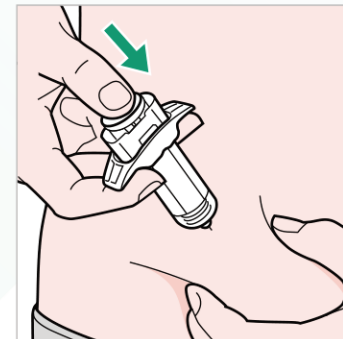

Release the pinched skin.

Slowly and evenly push the syringe plunger all the way down until the plunger stops and the pre-filled syringe is empty.

Note: You will feel some resistance. This is normal.

STEP 11: RELEASE THE PLUNGER AND REMOVE THE PRE-FILLED SYRINGE

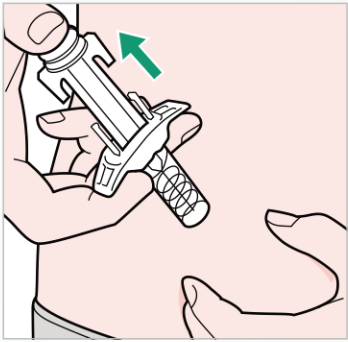

Lift your thumb to release the plunger rod until the needle is covered by the needle shield, and then remove the syringe from the injection site. Lightly press a cotton ball or gauze on the injection site if you see any blood.

- ! Do not put the needle shield back on the pre-filled syringe.
- ! Do not rub your skin after the injection.

STEP 12: DISPOSAL

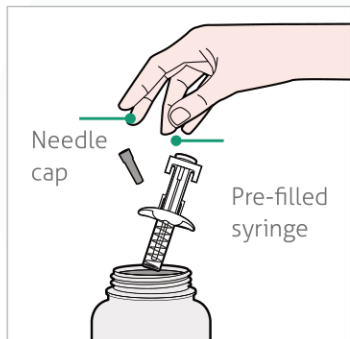

Dispose of the pre-filled syringe and the needle shield in a puncture-resistant container.

- ! Do not put the needle shield back on the pre-filled syringe.

Always keep the container out of the sight and reach of children.

HOW TO STORE DUPIXENT®

If your doctor decides that you may inject DUPIXENT® yourself at home, it is important to note the following information about storage and transportation:

- Keep the pre-filled syringe(s) out of the sight and reach of children.
- Store unused pre-filled syringes in the original packaging in the refrigerator at temperatures between 2 °C and 8 °C.
- Do not store DUPIXENT® for more than 14 days at room temperature (< 25 °C).

If you need to remove the carton permanently from the refrigerator, note the date when you took it out of the refrigerator in the space provided on the outer carton and use DUPIXENT® within 14 days. Do not return the pre-filled syringe to the refrigerator and dispose of the pre-filled syringe if it is not used within the specified time.

- **Never** shake the pre-filled syringe.
- **Never** heat the pre-filled syringe.
- **Do not** freeze the pre-filled syringe.
- **Do not** expose the pre-filled syringe to direct sunlight.

IMPORTANT:

Never change your medication by yourself. Always speak with your doctor to determine whether you need to take the prescribed medication less often or can stop taking it altogether. Our service team is available to answer any questions you may have about DUPIXENT® and its application:

MedInfo

☎ 0800 0 436996

@ MedInfo.de@Sanofi.com

Calls are free of charge for you from German networks.

STEP 11: REMOVE

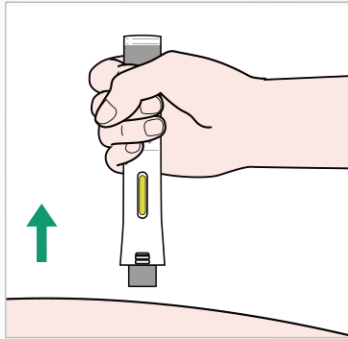

- When the injection is finished, pull the pre-filled pen straight up away from the skin and dispose of the pen immediately as described in Step 12.
- If you see any blood, press carefully on the injection site with a piece of cotton wool or gauze.

! Do not rub your skin after the injection.

STEP 12: DISPOSAL

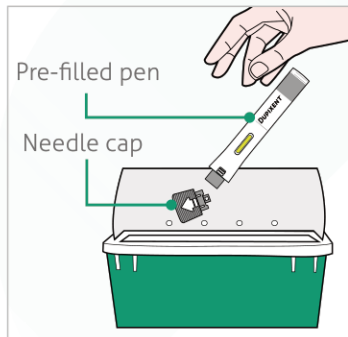

Dispose of the pre-filled pen (with needle inside) and needle cap in a puncture-resistant container immediately after use.

Do not dispose of (throw away) pre-filled pens (with needle inside) or needle caps in your household waste.

Note: Always keep the container out of the sight and reach of children

! Do not put the shield back on.

HOW TO STORE DUPIXENT®

If your doctor decides that you may inject DUPIXENT® yourself at home, it is important to note the following information about storage and transportation:

- Keep the pre-filled pen(s) out of the sight and reach of children.
- Store unused pre-filled pens in the original packaging in the refrigerator at temperatures between 2 °C and 8 °C.
- Store the pre-filled pens in their original packaging in order to protect them from light.
- **Do not store DUPIXENT®** for more than 14 days at room temperature (< 25 °C).

If you need to remove the carton permanently from the refrigerator, note the date when you took it out of the refrigerator in the space provided on the outer carton and use DUPIXENT® within 14 days. Do not return the pre-filled pen to the refrigerator and dispose of the pre-filled pen if it is not used within the specified time.

- **Never** shake the pre-filled pen.
- **Do not** heat the pre-filled pen.
- **Do not** freeze the pre-filled pen.
- **Do not** place the pre-filled pen in direct sunlight.

IMPORTANT:

Never change your medication by yourself. Always speak with your doctor to determine whether you need to take the prescribed medication less often or can stop taking it altogether. Our service team is available to answer any questions you may have about DUPIXENT® and its application:

MedInfo

☎ 0800 0 436996

@ MedInfo.de@Sanofi.com

Calls are free of charge for you from German networks.

STEP 7: REMOVE THE SHIELD

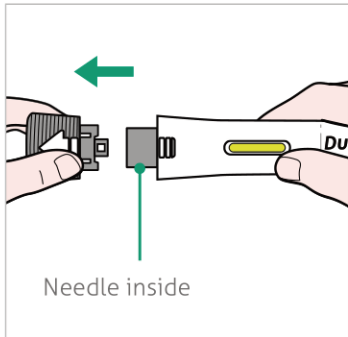

Pull the shield straight off. Do not twist off the shield.

- **Only remove** the shield when you are ready to inject.
- **Do not press or touch** the needle cover with your fingers. The needle is located inside.

! **After removing the shield, do not put it back on the pre-filled pen.**

STEP 8: POSITION THE PRE-FILLED PEN

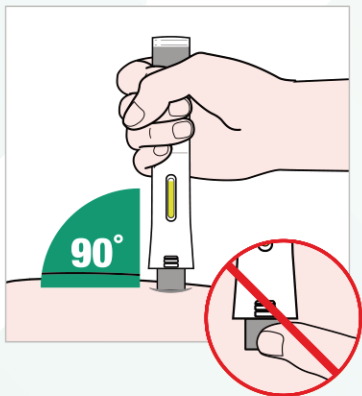

When positioning the needle cover on your skin, hold the pre-filled pen so that you can see the viewing window.

- Position the needle cover at an approximate 90° angle against your skin.

! **Do not press or touch the needle cover with your fingers. The needle is located inside.**

STEP 9: PRESS DOWN

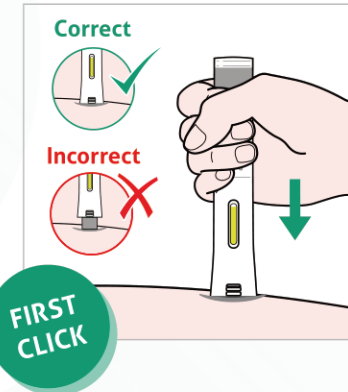

Press the pre-filled pen firmly against your skin until you can no longer see the needle cover and hold this position.

- A click is heard at the start of the injection.
- The viewing window turns yellow.

Note: The injection can take up to 15 seconds.

STEP 10: HOLD DOWN

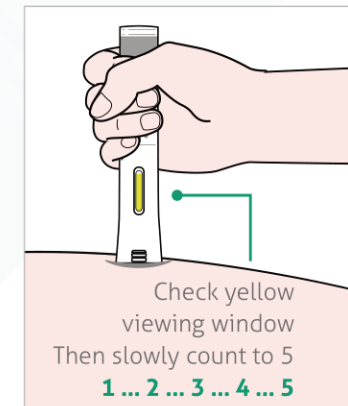

Keep holding the pre-filled pen pressed firmly against your skin.

- You may hear a second click.
- Check that the entire window has turned to yellow.
- Then count to five slowly.
- Then take the pre-filled pen off your skin – your injection is finished.

If the viewing window does not turn completely yellow, remove the pre-filled pen and call your healthcare provider.

! **Do not administer a second dose without first speaking to your doctor.**

STEP 3: LOOK AT THE MEDICINE

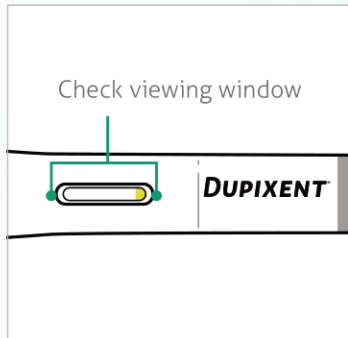

Look at the medicine through the viewing window of the pre-filled pen. Check that the liquid is clear and colourless to pale yellow.

Note: You might see an air bubble. This is normal.

- Do not use the pre-filled pen if the liquid is cloudy or discoloured or if it contains precipitates or particles.
- Do not use the pre-filled pen if the viewing window is yellow.

STEP 4: WAIT 30 MINUTES (FOR 200 MG DUPIXENT®) OR 45 MINUTES (FOR 300 MG DUPIXENT®)



Lay the pre-filled pen on a flat surface for at least 30 or 45 minutes until it reaches room temperature (below 25°C).

- Do not warm the pre-filled pen in the microwave, using hot water or by placing it in direct sunlight.
- Do not expose the pre-filled pen to direct sunlight.
- Do not store DUPIXENT® for more than 14 days at room temperature.

STEP 5: SELECT THE INJECTION SITE

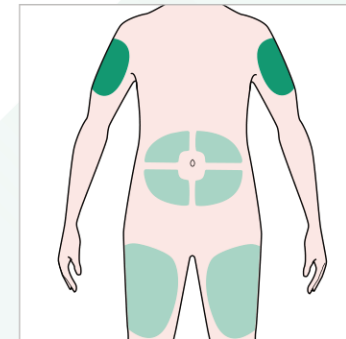

■ Self-injection or injection by a caregiver

■ Injection only by a caregiver

Select the injection site.

- You can inject into your thigh or abdomen (lower abdomen) but keep 5 cm away from your navel.
- If someone else gives the injection, the upper arm can also be injected.
- Change the injection site each time you inject.

■ Do not inject through clothing.

■ Do not inject into skin that is tender, injured, scarred or bruised.

STEP 6: CLEAN THE INJECTION SITE



- Wash your hands.
- Clean the injection site with an alcohol wipe.
- Allow the skin at the injection site to dry before injecting.

■ Do not touch the injection site again or blow on it before the injection.

COMPONENTS OF THE DUPIXENT® PRE-FILLED PEN

BEFORE USE

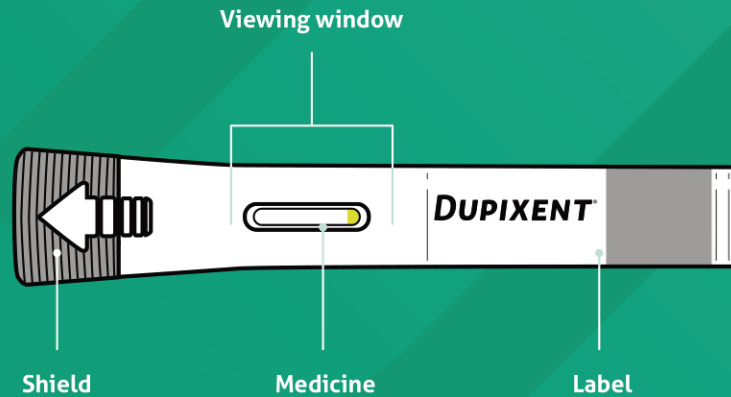

AFTER USE

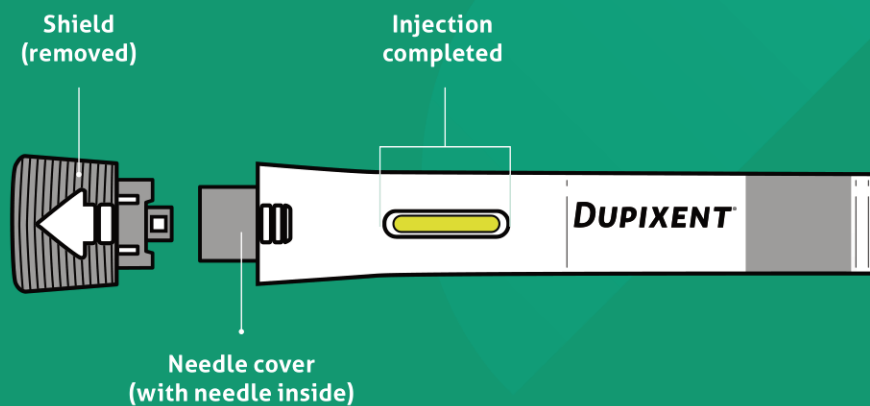

01 STEP-BY-STEP INSTRUCTIONS FOR ADMINISTERING A DUPIXENT® PRE-FILLED PEN

STEP 1: PREPARATION

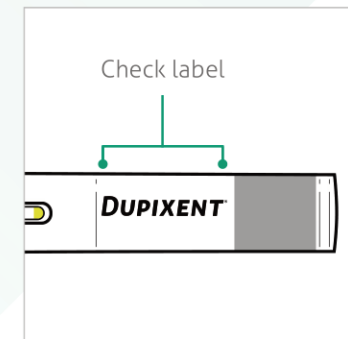

Ensure that you have the following items ready:

- DUPIXENT® pre-filled pen
- 1 alcohol wipe*
- 1 piece of cotton wool or gauze wipe*
- 1 puncture-resistant container* (see step 12)

Look at the label:

- Make sure that you have the correct medicine and the correct dose.

*Not included in the outer carton.

STEP 2: CHECK THE EXPIRY DATE

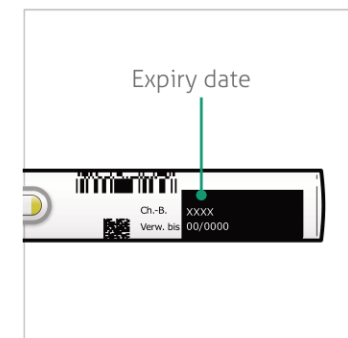

Check the expiry date.

- ! **Do not use the pre-filled pen after the expiry date.**
- ! **Do not store DUPIXENT® for more than 14 days at room temperature.**

DEAR PATIENT

Your doctor has prescribed you DUPIXENT® solution for injection in the form of a pre-filled pen.

DUPIXENT® is injected under the skin once every 2 weeks – a type of administration known as subcutaneous injection. Each pre-filled pen contains a dose of 200mg or 300mg DUPIXENT®. The dose must be administered in full and must not be divided. The dose to be administered is determined by your doctor.

Your doctor will decide with you whether you should inject DUPIXENT® yourself and when you should do it. Only inject DUPIXENT® yourself if you have been instructed to do so beforehand by your treatment team. For adolescents over 12 years of age, it is recommended that DUPIXENT® be administered by an adult or under adult supervision.

Note:

This brochure is intended to supplement the package leaflet, not replace it. Make sure you read the package leaflet in its entirety before starting the therapy. The package leaflet is included in every pack of DUPIXENT®. You can also find it online at: www.mein.sanofi.de/produkte/Dupixent.

IMPORTANT INFORMATION

- Read all the directions in the instructions for use through carefully before using the pre-filled pen.
- Ask your doctor, pharmacist or nurse how often you must inject DUPIXENT®.
- Make sure your treatment team show you how to use the pre-filled pen correctly before you give yourself an injection for the first time.
- Change the puncture site (injection site) each time you inject.
- **Do not use the pre-filled pen** if it is damaged.
- **Do not use the pre-filled pen** if the shield is missing or not correctly attached.
- **Do not press or touch** the needle cover with your fingers.
- **Do not inject** through clothing.
- **Only remove** the shield just before the injection.
- **Do not put the shield** back on the pre-filled pen.
- **Do not reuse** the pre-filled pen.

USING DUPIXENT® CORRECTLY

A guide to correctly using the DUPIXENT® pre-filled pen

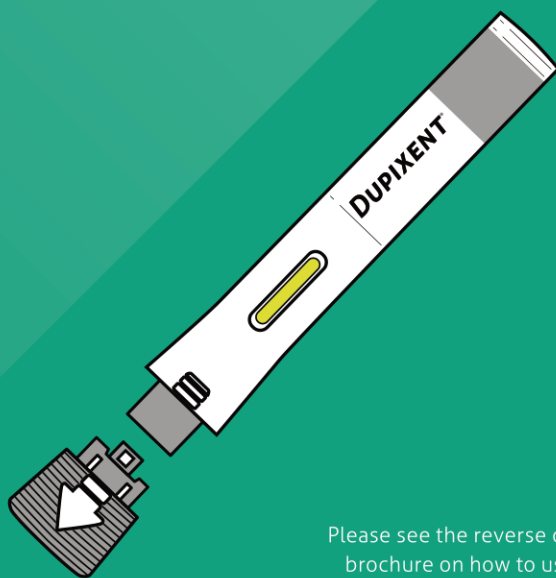

Please see the reverse of this brochure on how to use the DUPIXENT® pre-filled syringe.

sanofi

REGENERON®